



Underseat Storage Unit Installation Instructions



For: Chevrolet / GMC Extended Cab 1998 - 2003

Part Number: 42650



WARNING

This product is designed to enhance the appearance of the vehicle and to shield the occupants from ordinary weather conditions. Do not rely in any way on the components of this product to contain occupants within the vehicle, or to protect against injury or death in the event of an accident. Never operate vehicle in excess of manufacturer's specifications.

WEAR SEAT BELTS AT ALL TIMES

Read and follow, precisely, all installation instructions provided when installing this product. Failure to do so could place occupants of the vehicle in a potentially dangerous situation. After installing or reinstalling, check to make sure it has been properly installed.

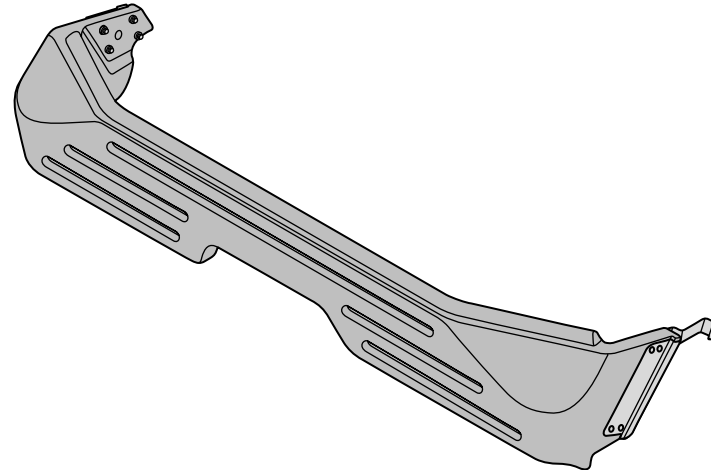

Parts List and Hardware Identification

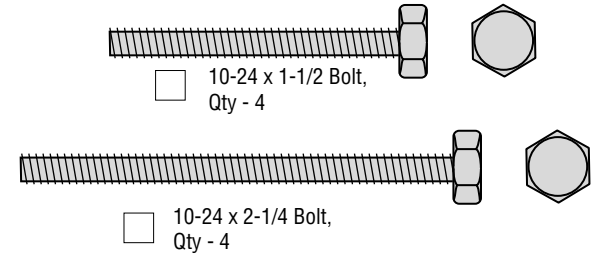
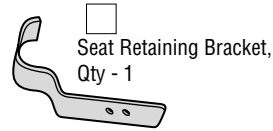
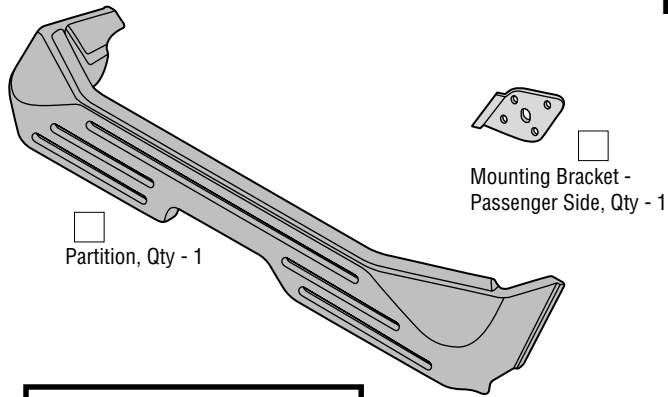

Tools Needed

3/8" Socket Wrench
7/8" Wrench
1/8" Allen Wrench
3/32" Allen Wrench
Scissors

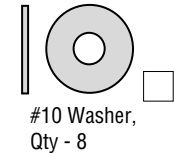
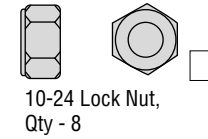
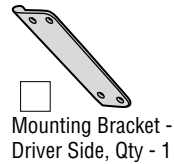

Installation

Step One

Raise the Rear Seat.

Pull the strap to release the seat and lift it up. If necessary, push down on the cushion to release the seat.

Step Two

Install BSR Tape on Driver and Passenger Mounting Brackets

Locate the Passenger and Driver Mounting Brackets in the Parts Kit. The BSR Tape will be installed on the flange on each bracket. Cut the tape to the desired length for each bracket. Peel the protective tape off the back of the strip and press the self-adhesive side of the BSR Tape onto each bracket.

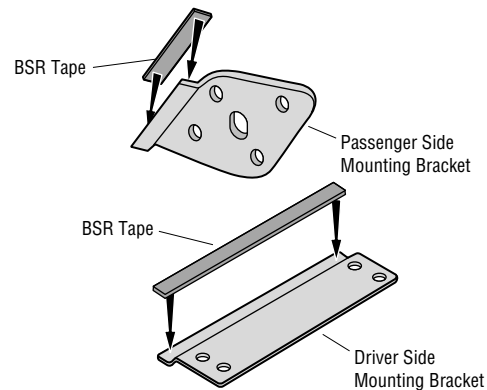

Step Three

Place Partition in vehicle.

Place the Partition in the vehicle. Hook the tab on the driver's side of the Partition to the ledge along the front of the seat base bracket on the driver's side. Snap the passenger side of the Partition into position so that the tab hooks to the ledge on the seat base bracket on the passenger side.

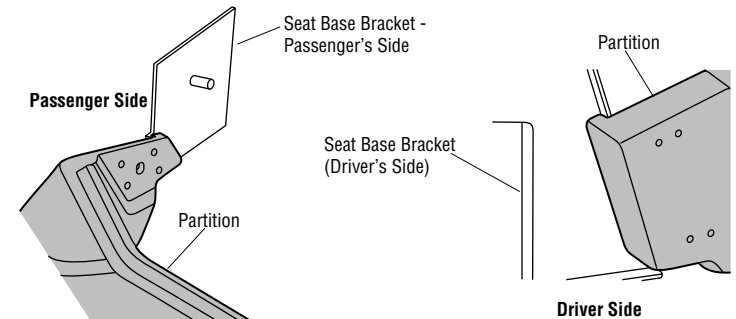

Step Four

Install Passenger Side Mounting Bracket.

Locate the Passenger Side Mounting Bracket in the Parts Kit. Place it on the outside of the Partition so that it aligns with the tab on the Partition. Install four 10-24 x 1.5" Bolts, four #10 Washers and four 10-24 Lock Nuts.

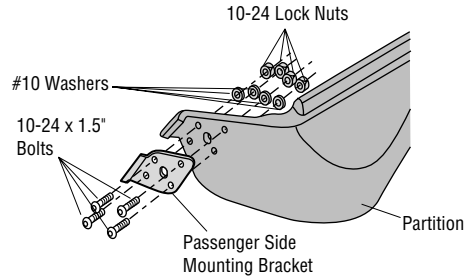

Step Five

Install Driver Side Mounting Bracket and Seat Retaining Bracket.

Locate the Driver Side Mounting Bracket and Seat Retaining Bracket in the Parts Kit. Place the mounting bracket on the outside of the Partition. Secure it in position with two 10-24 x 2.25" Bolts, two #10 Washers and two 10-24 Lock Nuts in the bottom holes. Place the Seat Retaining Bracket over the top holes inside the Partition so that it hooks around the seat brace. Install the remaining 10-24 x 2.25" Bolts, #10 Washers and 10-24 Lock Nuts. Tighten to 13Nm.

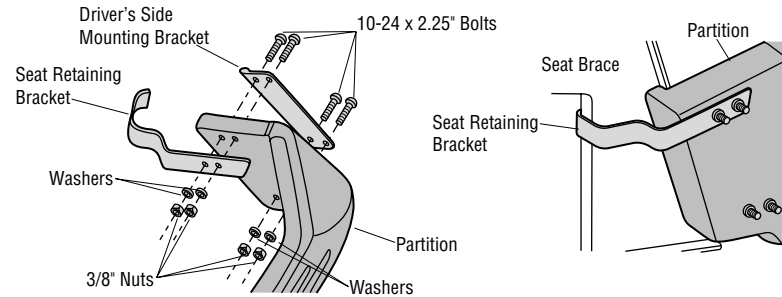

LIMITED WARRANTY

We warrant our product to be free from defects in material and workmanship, for terms specified below, provided there has been normal use and proper maintenance. This warranty applies to the original purchaser only. All remedies under this warranty are limited to the repair or replacement of any item or items found by the factory to be defective within the time period specified.

If you have a warranty claim, first you must call our factory at the number below for instructions. You must retain proof of purchase and submit a copy with any items returned for warranty work. Upon completion of warranty work, if any, we will return the repaired or replaced item or items to you freight prepaid. Damage to our products caused by accidents, fire, vandalism, negligence, misinstallation, misuse, Acts of God, or by defective parts not manufactured by us, is not covered under this warranty.

THE WARRANTY TIME PERIOD IS AS FOLLOWS: ALL "HARD GOODS" MANUFACTURED BY OUR COMPANY (USING PRIMARILY VINYL, PLASTICS, AND/OR FOAM): ONE YEAR FROM DATE OF PURCHASE.

ANY IMPLIED WARRANTIES OF MERCHANTABILITY AND/OR FITNESS FOR A PARTICULAR PURPOSE CREATED HEREBY ARE LIMITED IN DURATION TO THE SAME DURATION AND SCOPE AS THE EXPRESS WRITTEN WARRANTY. OUR COMPANY SHALL NOT BE LIABLE FOR ANY INCIDENTAL OR CONSEQUENTIAL DAMAGE.

Some states do not allow limitations on how long an implied warranty lasts, or the exclusion or limitation of incidental or consequential damages, so the above limitations or exclusions may not apply to you.

This warranty gives you specific legal rights, and you may also have other rights which vary from state to state.

For further information or request for warranty work, please contact:

Bestop Inc.
Customer Service
(800)346-3910
(303)465-1755