



Console

Installation Instructions

For: *Geo Tracker / Suzuki Sidekick / Suzuki Samurai (1986-1993)*

Part Number: 81562

WARNING

This product is designed primarily to enhance the appearance of the vehicle and to shield the occupants from ordinary weather conditions. Do not rely in any way on the components of this product to contain occupants within the vehicle, or to protect against injury or death in the event of an accident. This product will not protect the occupants from falling objects. Never operate vehicle in excess of manufacturer's specifications.

WEAR SEAT BELTS AT ALL TIMES

Read and follow, precisely, all installation instructions provided when installing the soft top. Failure to do so may result in a poor fitting canopy and could place occupants of the vehicle in a potentially dangerous situation.

Parts List and Hardware Identification

Console Box

Qty - 1



Front Mounting Bracket, Qty - 1



Rear Mounting Bracket, Qty - 1

Tools Needed

1/8" Drill Bit and Drill Motor
Phillips Screwdriver
3/8" Wrench
Awl

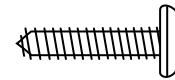

#8 x 3/4" Pan Head Screw, Qty - 4,
Part Number 271.68

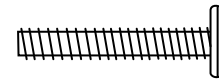

#10-24 x 1" Pan Head Machine Screw,
Qty - 4, Part Number 284.12



#10-24 Locknut, Qty - 4,
Part Number 195.93



3/16" Aluminum Washer, Qty - 4,
Part Number 225.93

Console Assembly

Step One

Remove the tray from the console. Locate the four small holes in the fabric on the bottom of the console. Using an awl, push up through the holes in the console and punch holes through the carpet on the bottom of the console box.

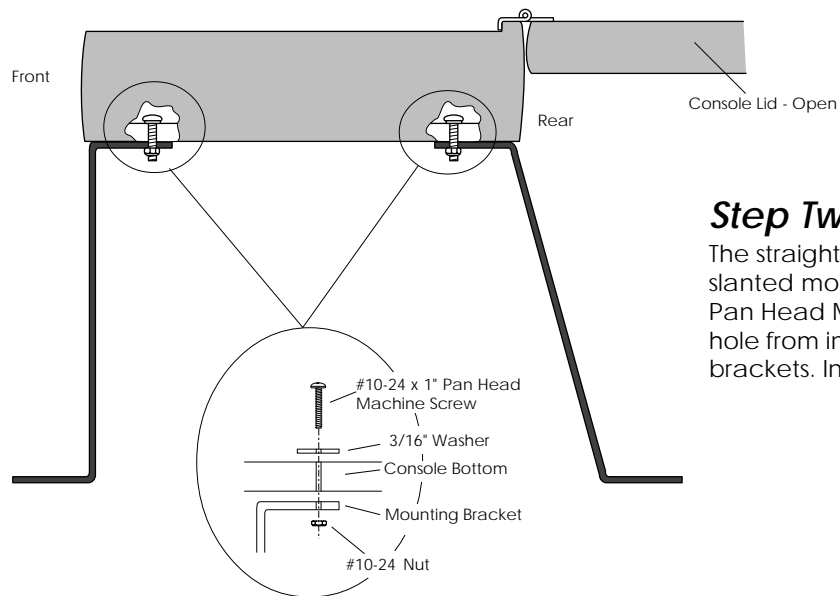
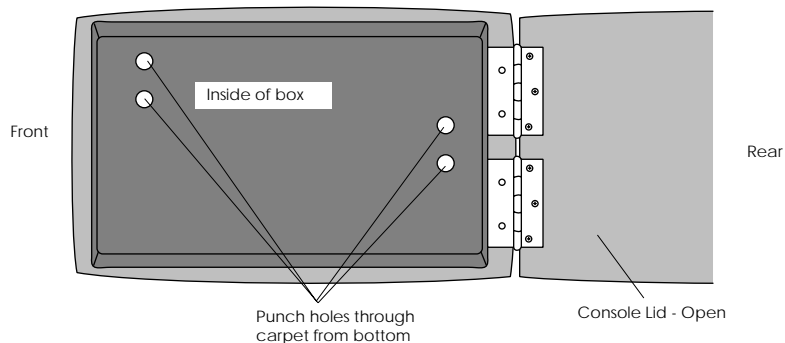
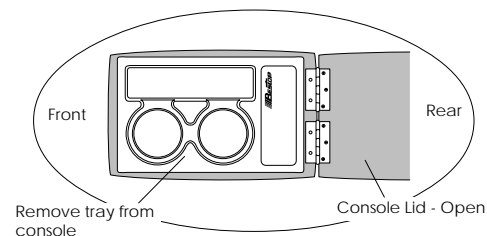

Step Two

The straight mounting bracket goes on the front and the slanted mounting bracket on the rear. Place a #10-24 x 1" Pan Head Machine Screw and a 3/16" Washer through each hole from inside the console box and through the mounting brackets. Install a nut on each screw and tighten all screws.

Geo Tracker and Suzuki Sidekick Installation

Step One

Place the Console between the seats, making sure that it is centered. The front mounting bracket will be on the passenger side of the parking brake assembly. Make sure that the console is located so that the parking brake can be operated easily. The front edge of the front foot on the mounting bracket should be even with the front edge of the plastic parking brake cover. The rear foot will be on the edge of an area in the floor where the carpet is not supported, make sure that the foot is on firm floor before installing the console.

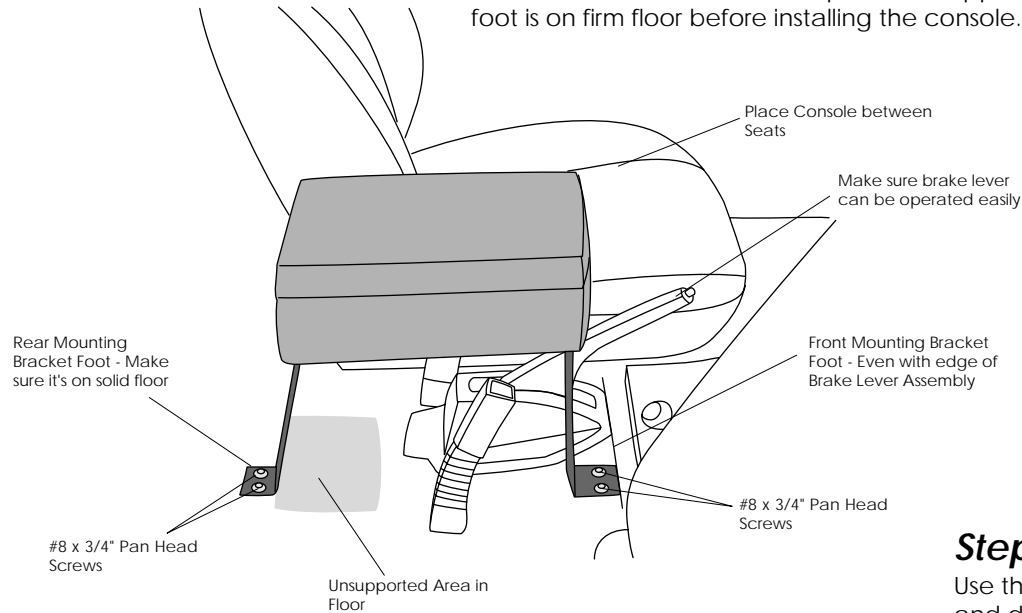

Step Two

Use the holes in the feet of the Mounting Bracket as guides and drill a 1/8" hole in the floor board of the vehicle. Install an #8 x 3/4" Pan Head Screw, tightening the screw only enough to hold the console steady. Then drill the three remaining holes and install the three remaining screws.

Warning: Check for wiring and fuel lines before drilling holes in floor.

Suzuki Samurai Installation

Step One

Place the Console between the seats, making sure that it is centered. The front mounting bracket will be on the passenger side of the parking brake assembly. Make sure that the console is located back far enough so that the parking brake can be operated easily. The front of the console box should be 16" - 17" from the front center panel of the dash. If the console is placed too far toward the rear of the vehicle the rear seat will not fold down properly. Check that there is enough room to fold down the seat before installing the console.

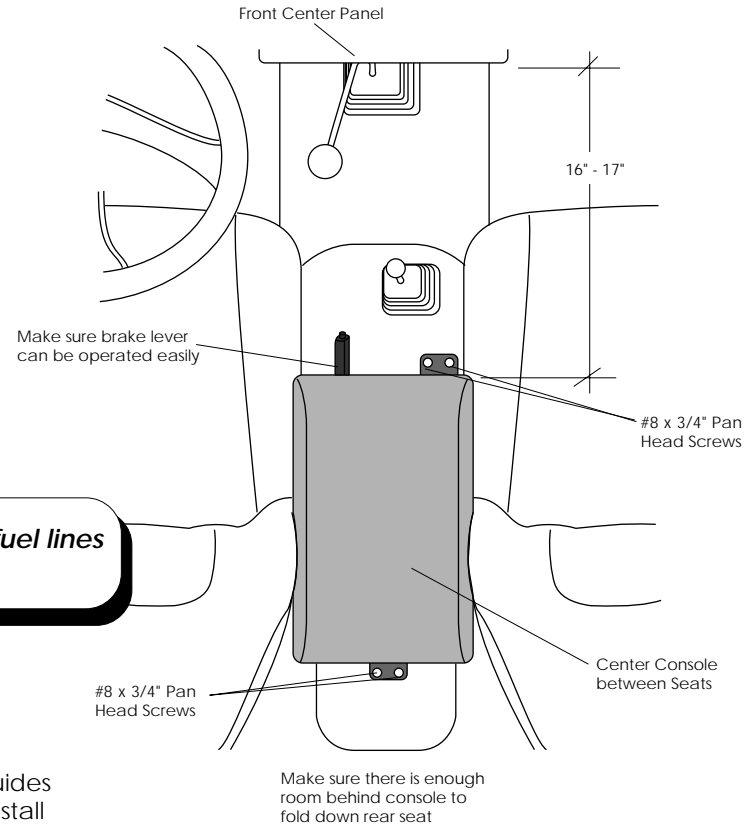

Warning: Check for wiring and fuel lines before drilling holes in floor.

Step Two

Use the holes in the feet of the Mounting Bracket as guides and drill a 1/8" hole in the floor board of the vehicle. Install an #8 x 3/4" Pan Head Screw, tightening the screw only enough to hold the console steady. Then drill the three remaining holes and install the three remaining screws.

LIMITED WARRANTY

We warrant our product to be free from defects in material and workmanship, for the terms specified below, provided there has been normal use and proper maintenance. This warranty applies to the original purchaser only. All remedies under this warranty are limited to the repair or replacement of any item or items found by the factory to be defective within the time period specified.

If you have a warranty claim, first you must call our factory at the number below for instructions. You must retain proof of purchase and submit a copy with any items returned for warranty work. Upon completion of warranty work, if any, we will return the repaired or replaced item or items to you freight prepaid. Damage to our products caused by accidents, fire, vandalism, negligence, misinstallation, misuse, Acts of God, or by defective parts not manufactured by us, is not covered under this warranty.

THE WARRANTY TIME PERIOD IS AS FOLLOWS: ALL "SOFT GOODS" MANUFACTURED BY OUR COMPANY (USING PRIMARILY VINYL, PLASTICS, AND/OR FOAM): ONE YEAR FROM DATE OF PURCHASE.

ANY IMPLIED WARRANTIES OF MERCHANTABILITY AND/OR FITNESS FOR A PARTICULAR PURPOSE CREATED HEREBY ARE LIMITED IN DURATION TO THE SAME DURATION AND SCOPE AS THE EXPRESS WRITTEN WARRANTY. OUR COMPANY SHALL NOT BE LIABLE FOR ANY INCIDENTAL OR CONSEQUENTIAL DAMAGE.

Some states do not allow limitations on how long an implied warranty lasts, or the exclusion or limitation of incidental or consequential damages, so the above limitations or exclusions may not apply to you.

This warranty gives you specific legal rights, and you may also have other rights which vary from state to state.

For further information or request for warranty work, please contact:

Bestop Inc.
Customer Service
(800)346-3910
(303)465-1755

