



Assembly Instructions EZ Roll Tonneau

Vehicle Application:
Chevrolet Silverado/GMC Sierra 6.5' Bed
2019 to Current (New Body Style)
Part Number: 19225

Installation Tips

Before you begin installing your new EZ Roll Tonneau Cover, please read all the instructions thoroughly.

Wash vehicle to ensure that no dirt or abrasive materials are caught between the truck's finish and the Tonneau Rail Frame.

Check and secure all clamps to bed frame as indicated in the installation instructions before operating your vehicle.

Tonneau cover clamps must be securely attached prior to vehicle operation.

Secure retaining straps when cover is in open position.

NOTE:

If the vehicle has an Over-The-Rail Bedliner, use a certified installer to perform the initial installation. Modifications may be required.



WARNING

The tie down straps must be fastened securely to avoid damage to personal property.



CAUTION

Safety glasses should be worn at all times when installing this product.

WEAR SEAT BELTS AT ALL TIMES

Tools



Safety Glasses

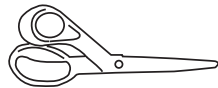

Scissors

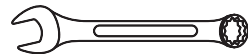

1/2" Wrench

Installation Time



30 minutes

Support

We're here to help! Go to:
<https://www.bestop.com>
and click on **Need Help?**

Skill Level



1 - Easy



<https://www.bestop.com/video-library>

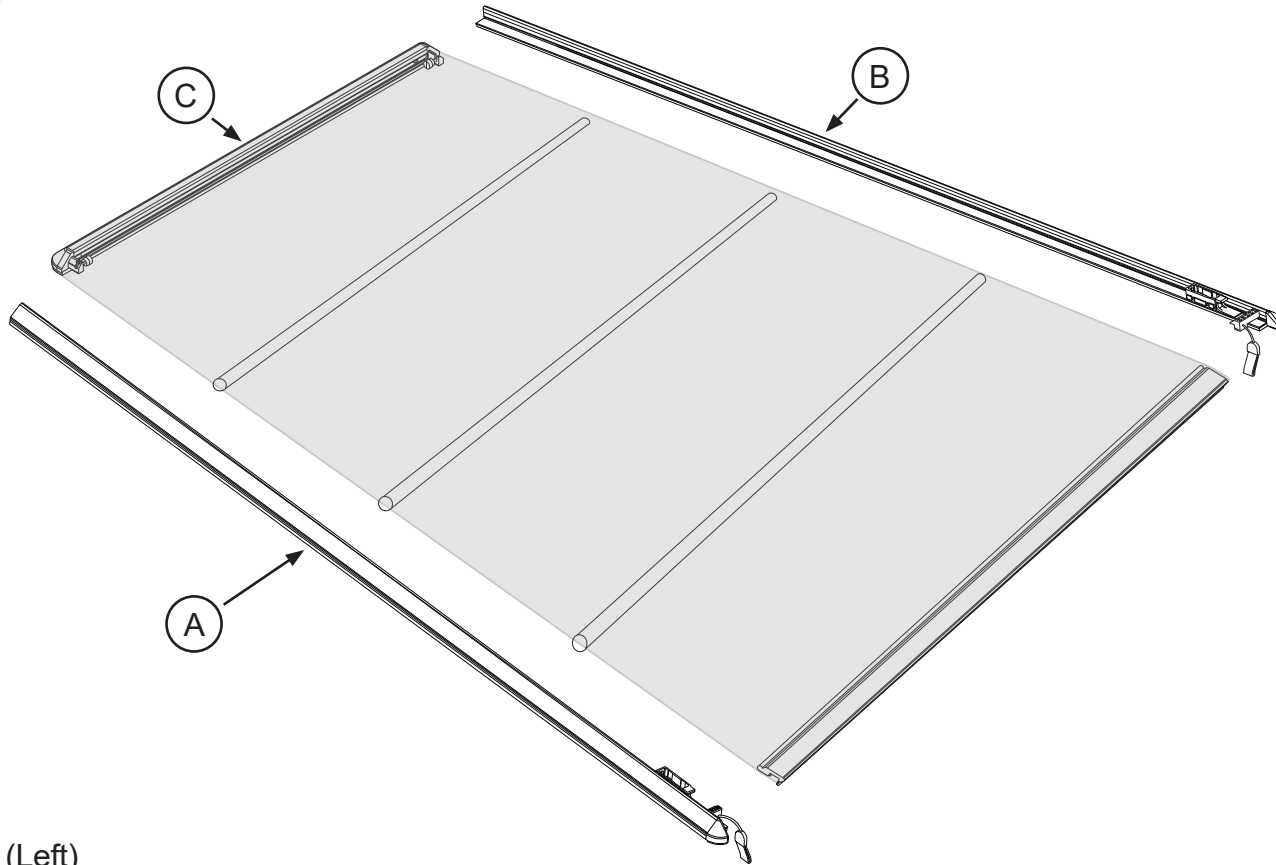

- A Side Rail (Left)
- B Side Rail (Right)
- C Cover Assembly
- D 5/16" Bolt (6 ea)
- E Outer Clamp Large (2 ea)
- F Outer Clamp Small (4 ea)
- G Inner Clamp (6 ea)
- H Rubber Pad (6 ea)

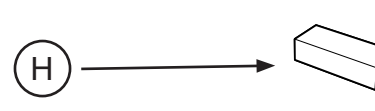
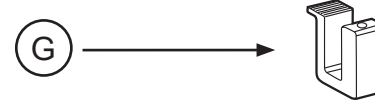

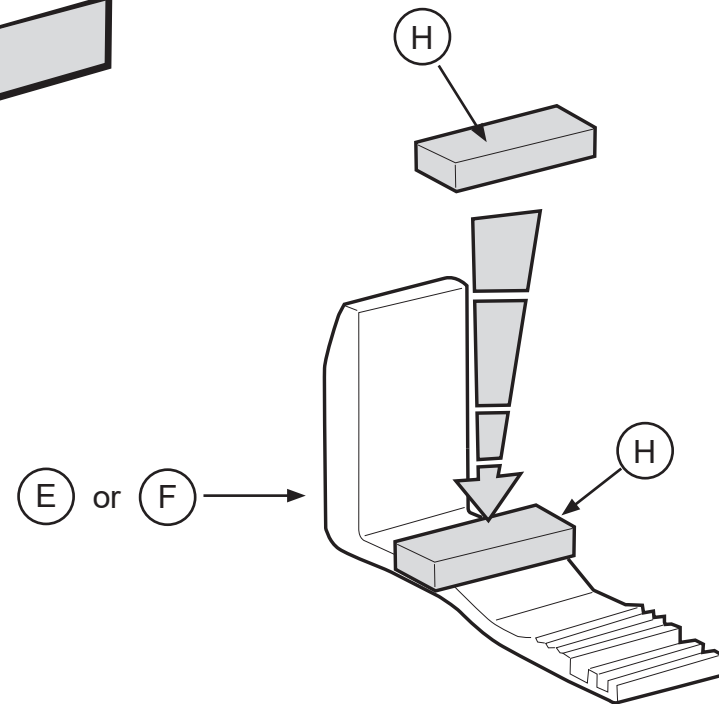
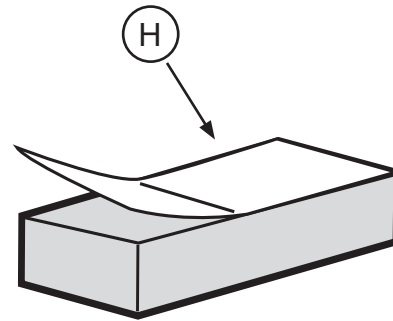
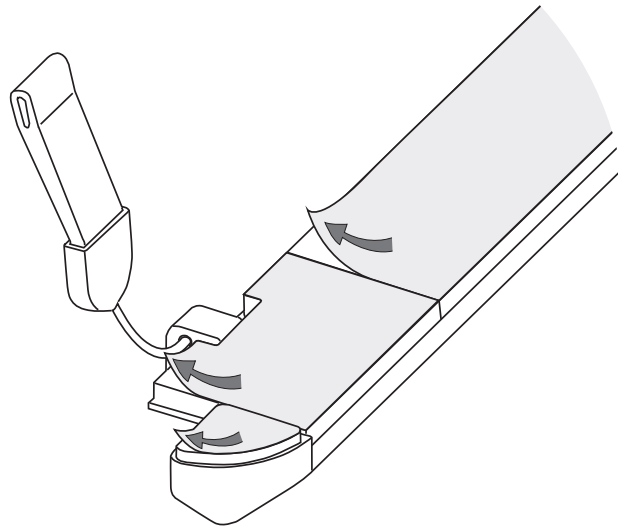



Fabric not shown for illustration purpose



Attach Side Rails to Cover Rail



Tighten Thumb Screws

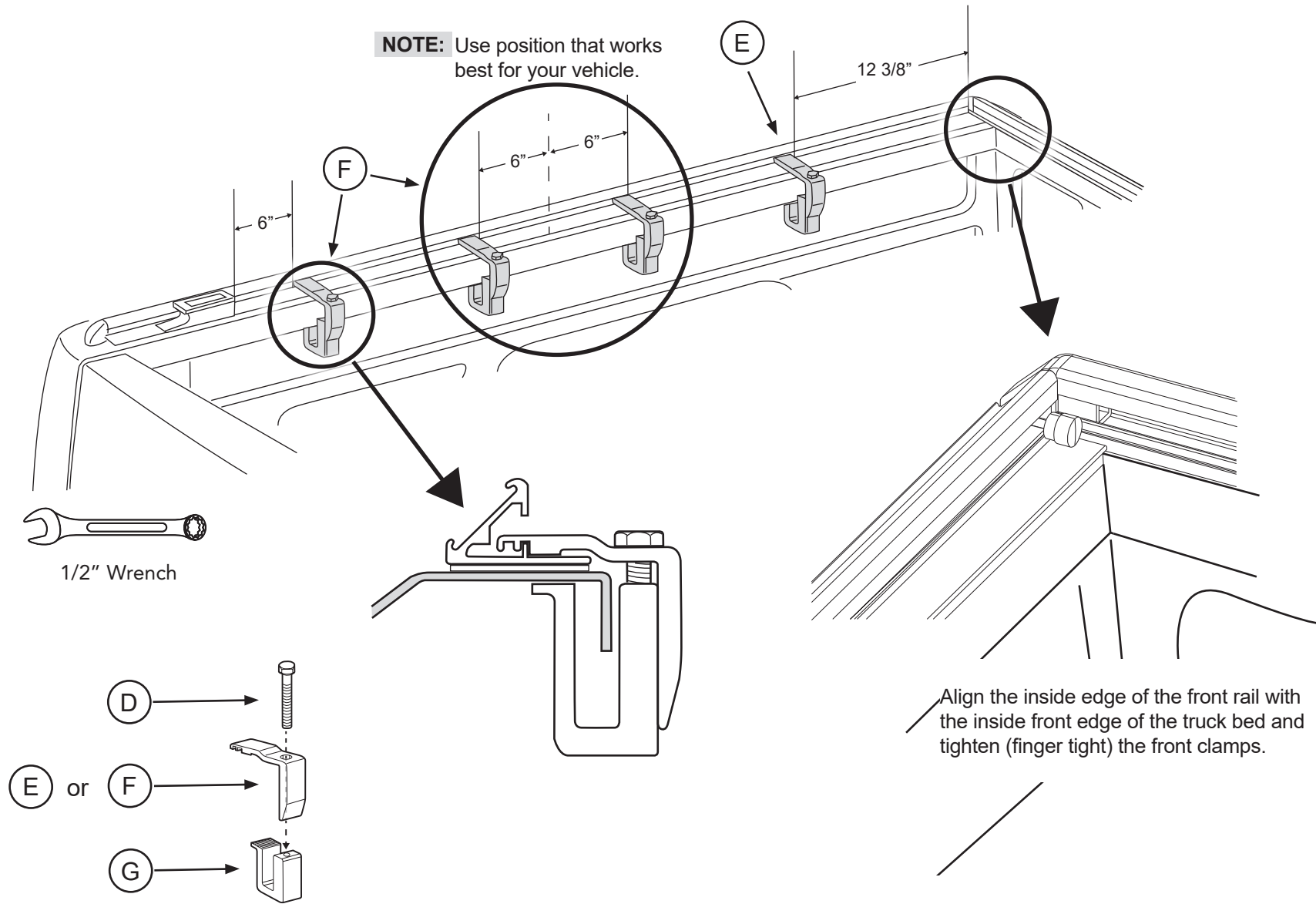



Disconnect the Roll Up Straps then unroll the Tonneau Cover.



Roll out the cover to make sure the bows fit between the rails.

NOTE: Allow a 1/8" gap between the side rails and the rear rail.

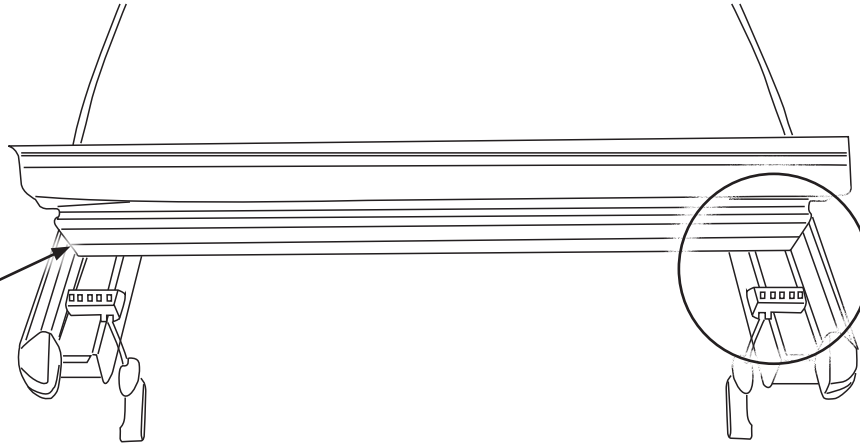

Push down until latch catches.



1/2" Wrench

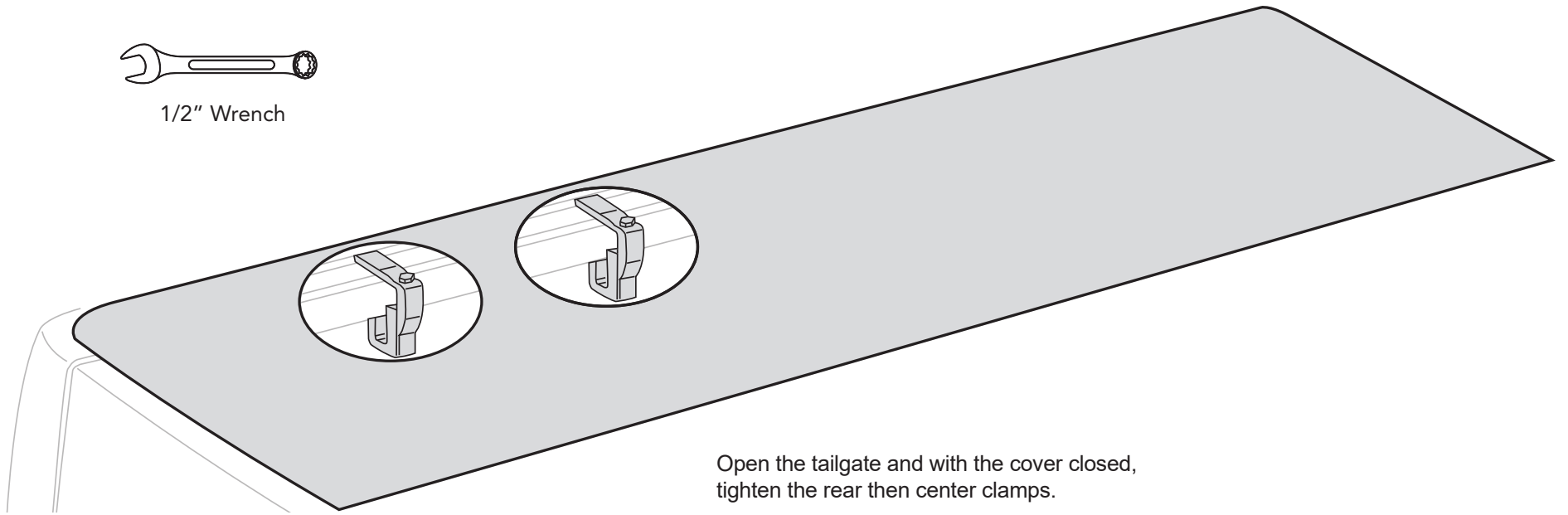

Open the tailgate and with the cover closed, tighten the rear then center clamps.



Pull tabs to release rear retainer .



Open the cover (Roll forward) then tighten the front clamps



Un-roll the cover and latch the tailgate retainer

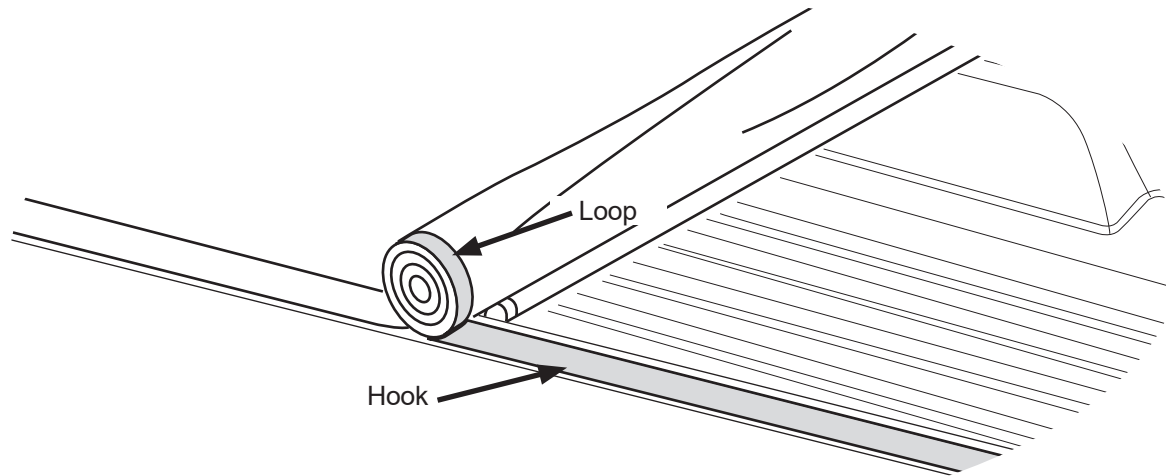

Pull the loop (on the fabric) tight from side to side to the hook (on the rail)



If your vehicle is equipped with a tailgate cap, you will need to trim the seal on the Tonneau Cover Assembly. Mark the seal at each end of the tailgate cap and use the scissors to trim the bottom part of the seal at the mark.

NOTE: Only trim the bottom part of the seal.



Care and Maintenance of your Bestop Product

Your Bestop product is made of the finest materials available. To keep it looking new and for the maximum possible wear, it will need periodic cleaning and maintenance.

Fabric: The fabric should be washed often using soap, warm water and a soft bristle brush. Rinse with clear water to remove all traces of soap. Bestop recommends using Bestop Cleaner (part no. 11201-00) and Bestop Protectant (part no. 11202-00) for Vinyl fabric and Bestop Twill Protectant (part no. 11207-00) for Twill fabric. Bestop Cleaner and Bestop protectant are specially formulated to provide a total cleaning and protection system. Bestop Cleaner safely removes the toughest stains, will not harm vehicle finishes, is biodegradable and environmentally friendly. Bestop Protectant protects against UV-fading, cracking and hardening, and repels dust, grease, dirt and mildew.

Windows: Keep windows clean to avoid scratching. **DO NOT** use a brush on the windows! Wash with a water-soaked cloth or sponge and a mild dishwashing detergent. Bestop recommends Bestop Vinyl Window Cleaner (part no. 11203-00), which safely cleans and protects vinyl windows and helps prevent UV damage. **NEVER WIPE THE WINDOWS WHEN THEY ARE DRY.** Be careful when cleaning snow or frost from the vinyl windows since they are easily scratched and may crack at low temperatures. **DO NOT** roll the sides or rear window in cold weather. The windows become stiff and will crack. Cracks caused by misuse in cold temperatures are not covered under warranty.

Water: Seeping through at the seams may be stopped by applying 3-M Scotchgard® on the inside of the seams.

Snaps: Keep snaps cleaned and lubricated with silicone to help prevent snaps from sticking to the studs. If a snap does become stuck to a stud, use a screwdriver and **GENTLY** pry apart to prevent permanent damage to the snap or the top fabric.

Zippers: Keeping zippers cleaned and lubricated with Bestop's Zipper Cleaner (part no. 11206-00) will help prevent damage and keep the zippers in smooth working condition. If a zipper opens behind the slider, the slider may have been spread apart. This problem can usually be repaired by using an ordinary pair of pliers to bring the sides back into parallel. Return slider to the end of the zipper in the normal Open position. Squeeze lightly at first and test the zipper. If the zipper continues to remain open squeeze more firmly with the pliers and try the zipper again. Repeat this procedure until the zipper operates correctly.



For Bestop Warranty Information, Please go to;
<https://www.bestop.com/help/warranty-information/>

