







Installation Instructions EZ Roll Tonneau

Part Number: 19240

www.Bestop.com - We're here to help! Visit our web site and click on "[Ask a Question](#)". Click here for more [Truck Accessories by Bestop](#).

INSTALLATION TIME	SKILL LEVEL
 1/2 Hour	 1 - Easy

TOOLS		
 Wrench 1/2"	 Scissors	 Safety Glasses

NOTE Wash vehicle to ensure that no dirt or abrasive materials are caught between the truck's finish and the Tonneau Rail Frame.

Check and secure all clamps to bed frame as indicated in the installation instructions before operating your vehicle.

Tonneau cover clamps must be securely attached prior to vehicle operation.

Secure retaining straps when cover is in open position.

 **CAUTION** Safety glasses should be worn at all times while installing this product.

Installation Tips

Before you begin installing this assembly, read all instructions thoroughly.

For a smooth fit:

For ease in installation, the product should be installed at temperatures above 72° F. Below this temperature, the fabric may contract an inch or more, making it difficult to fit to the vehicle. It is normal for fabric to contract and wrinkle when stored in the shipping carton. Within a few days after the installation, the fabric will relax and the wrinkles will disappear.

 **WARNING** The buckle of each retaining strap and both clamps must be fastened securely to avoid damage to personal property or possible personal injury.

If the vehicle has an Over-the-Rail Bedliner, use a certified installer to perform the initial installation. Modifications to the Bedliner may be required.

EZ Roll Tonneau Installation Instructions

Parts List

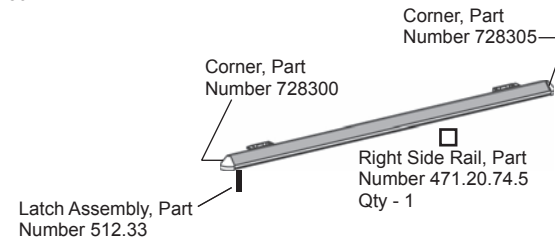
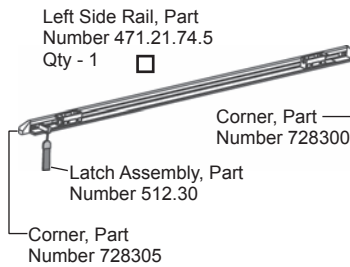
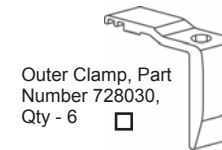
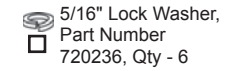
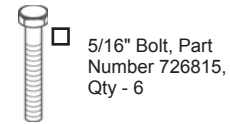
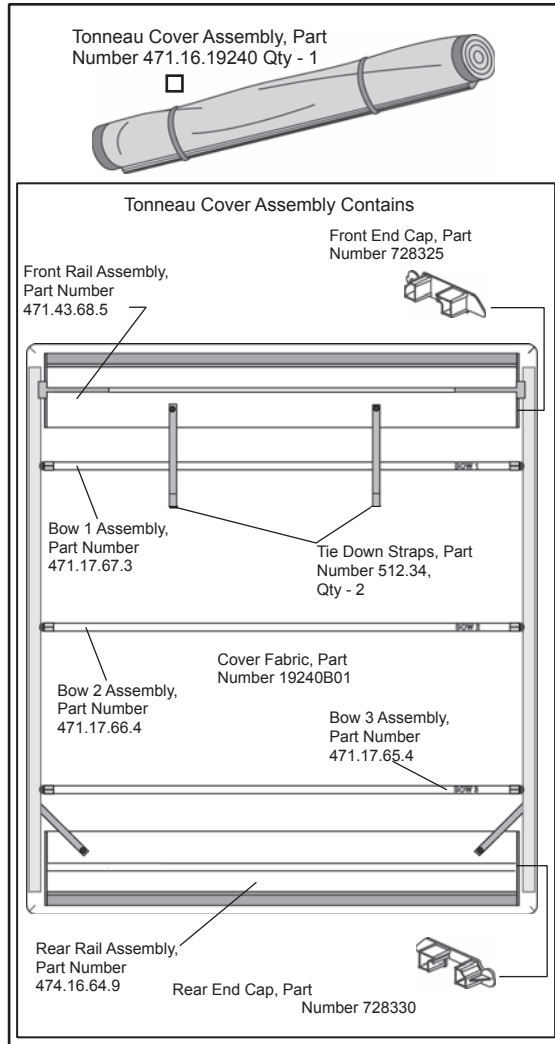

EZ Roll Tonneau Installation Instructions

1 Assemble Clamps

Use a 5/16" Bolt and 5/16" Lock Washer to secure an Outer Clamp to an Inner Clamp. Repeat for six (6) assemblies.

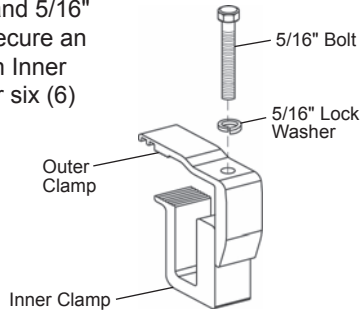

2 Place Side Rails on Bed

Locate the 2 side rails. Remove the protective tape on the bottom of each rail and place the rail on the bed on each side of the vehicle.

Once the rails are on the bed, align the front edge of each Side Rail, with the inside edge of the front bulkhead.

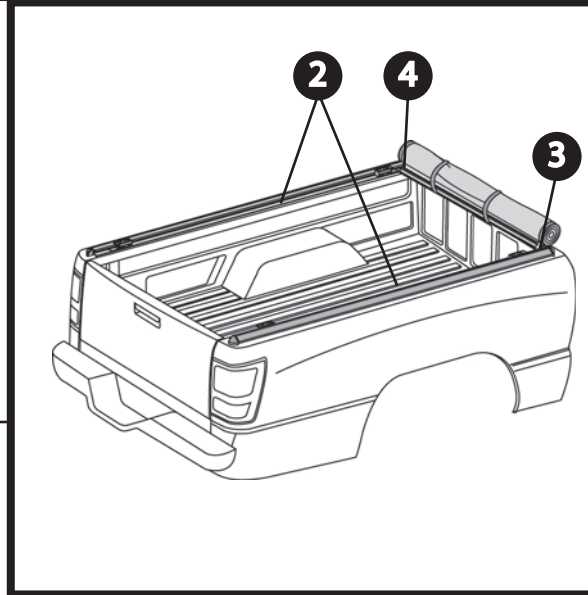
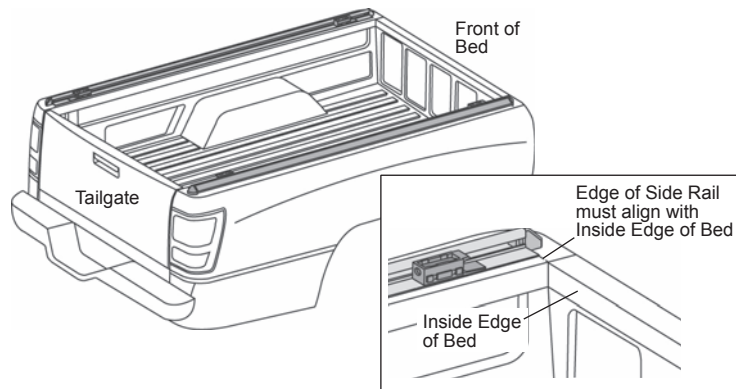

3 Secure Tonneau Cover Assembly to Passenger Side Rail

Place the Tonneau Cover Assembly into the front pivot on the Passenger Side Rail. Engage the cover assembly latch into the slot on the Side Rail. Make sure that the cover assembly is flush against the Side Rail.

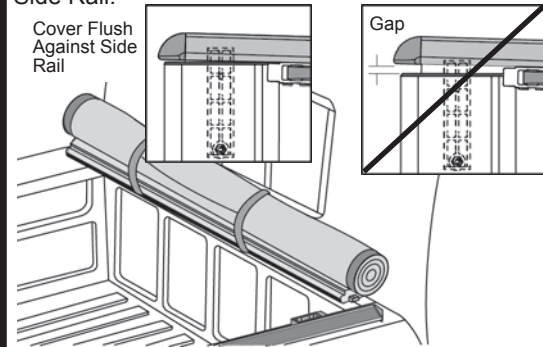

4 Secure Driver Side Rail to Tonneau Cover Assembly

Place the Driver's Side Rail into the Tonneau Cover Assembly. Make sure the cover assembly latch is fully engaged into the slot on the Side Rail and that the cover assembly is flush against the Side Rail.

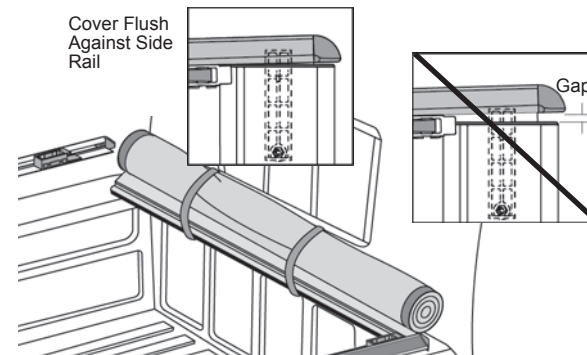

EZ Roll Tonneau Installation Instructions

5 Place Clamps

Place the front clamp on the Side Rail 6" behind the front pivot mount. Place the rear clamp 6" in front of the rear pivot mount. Locate the center of the Side Rail and place the center clamp either 6" in front of this point or 6" behind it as needed for your vehicle.

Do Not Tighten the Clamps at this time.

Repeat on both sides of the vehicle.

NOTE Clamp positions may vary depending on any bed accessories you may have.

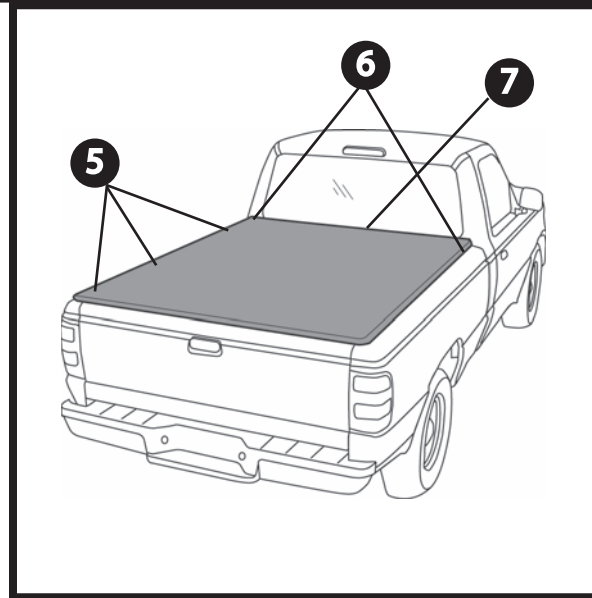

6 Un-do Straps

Un-do the Tie Down Straps.

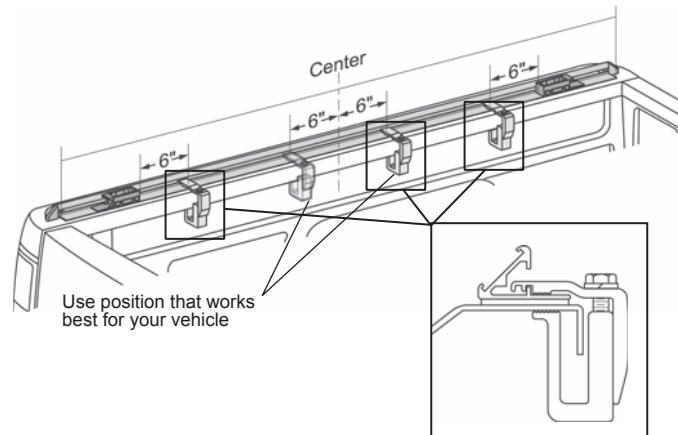

7 Center Tonneau Frame

With the Tonneau Cover Assembly latched on both sides, push both Side Rails in so they are flush with the Front Rail. Center the front of the Frame from side to side on the vehicle.

NOTE For proper function, it is best to leave a 1/8" gap between the Side Rail and the Front Rail.

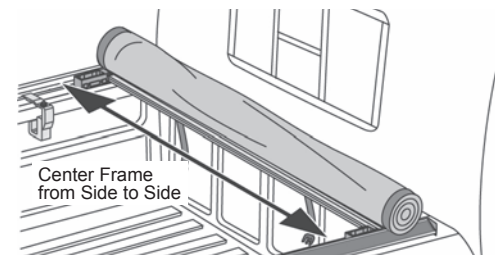

EZ Roll Tonneau Installation Instructions

8 Tighten Front Clamps

Tighten the front Clamp on each side until the Lock Washer is compressed.



11 Center Rear of Frame

Push the Side Rails flush against the Rear Rail and center the rear of the Frame from side to side on the vehicle.

NOTE For proper function, it is best to leave a 1/8" gap between the Side Rail and the Rear Rail.



9 Roll Out Cover

Roll out the cover. Make sure that each bow falls between the Side Rails.



10 Secure Rear Rail To Rear Pivot Mounts

Rotate the Rear Rail into the rear Pivot Mounts on both sides. It will only latch on the driver's side.



12 Secure Remaining Clamps

Once the Frame is centered reach between the cover and the Side Rail to access the center and rear clamps. Tighten the 5/16" Bolt in the Clamp until the Lock Washer is compressed, then add 1 to 1-1/2 additional turns to reach optimum pressure. Repeat on both sides of the vehicle.

NOTE Do not remove the cover until all clamps are tight.

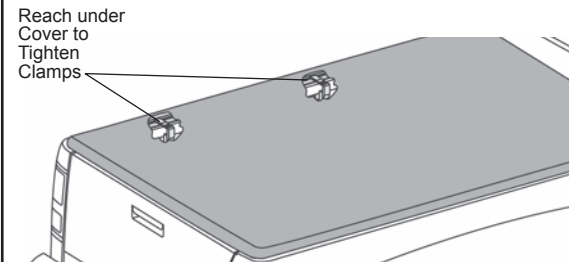

EZ Roll Tonneau Installation Instructions

13 Secure Sides of Cover

Fasten the loop strip sewn to the driver's side of the Tonneau Cover to the hook on the Side Rail. Pull the fabric tight across and secure the passenger side.

NOTE Make sure to keep the fabric tight across the bed to ensure a proper fit.

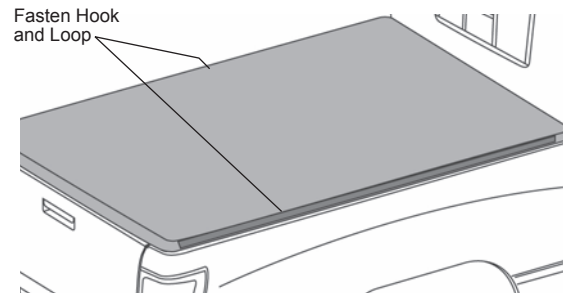

16 To Remove Cover – Loosen Side Rail

Loosen the front and middle clamps on the Driver's Side Rail. Pull outward on the rail until the cover disengages from the Side Rail.

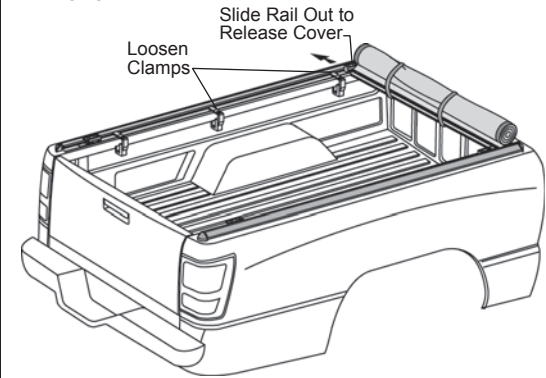

14 To Remove Cover – Release Latches

Open the tailgate and pull both the drivers side latch and the passenger side latch to rear of vehicle.



15 To Remove Cover – Roll Cover

Tightly roll the Cover toward the front and attach strap to the 2 front loop attachments.



17 Remove Cover

Remove the Cover Assembly from the vehicle.

NOTE Once the Cover is removed, retighten the clamps on the Side Rail.

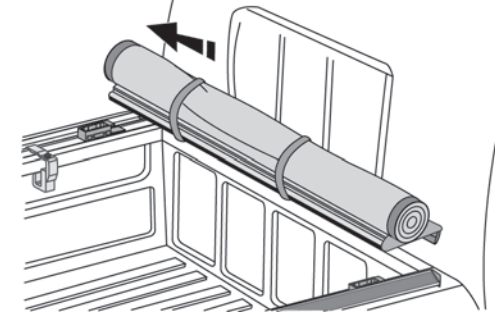

EZ Roll Tonneau Installation Instructions

18 Special Instructions – Bed Liners

If your vehicle is equipped with a Bed Liner that comes up over the front bulkhead, you will need to trim the seal on the Tonneau Cover Assembly. Mark the seal at each end of the of the Bed Liner and use scissors to trim the bottom, “eyelash”, part of the seal at the mark.

NOTE Only trim the bottom, “eyelash”, part of the seal.

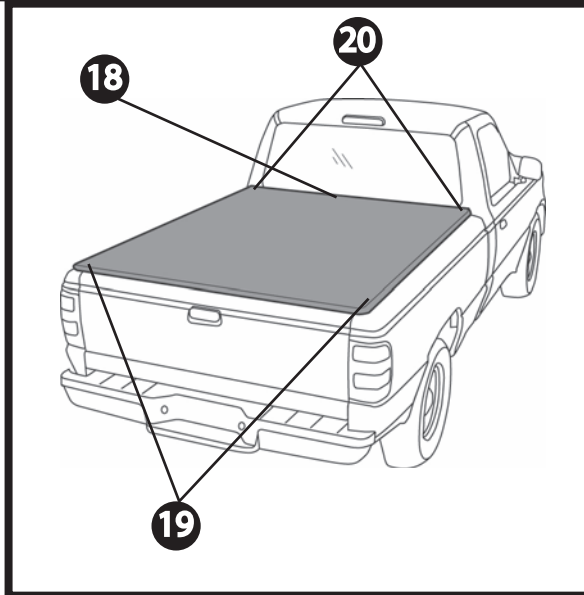
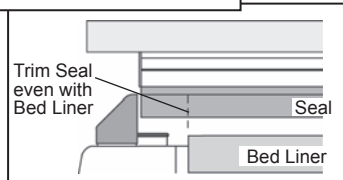
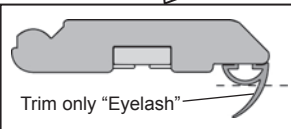
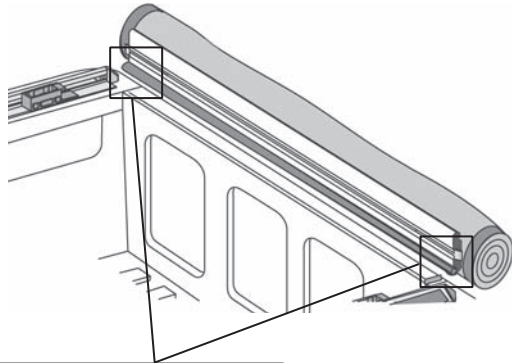

19 Special Instructions – Tailgate Caps

If your vehicle is equipped with a Tailgate Cap, you will need to trim the seal on the Tonneau Cover Assembly. Mark the seal at each end of the of the Tailgate Cap and use scissors to trim the bottom part of the seal at the mark.

NOTE Only trim the bottom part of the seal.

20 Cover Tension Adjustment

Use a 1/4" Allen Wrench to adjust the tension on the cover.

NOTE Make sure the tension is the same on both sides of the vehicle.

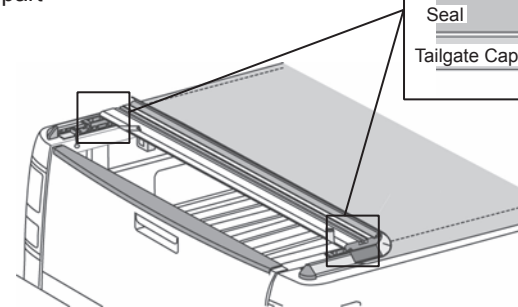
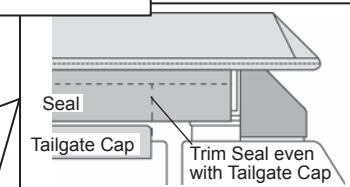
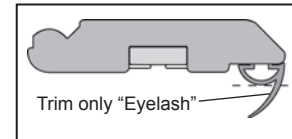
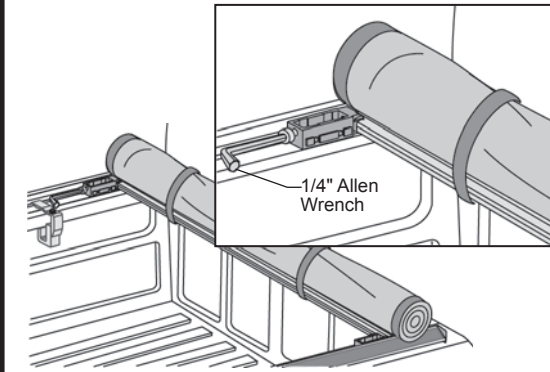

EZ Roll Tonneau Installation Instructions

Care and Maintenance of your Bestop Product

Your Bestop product is made of the finest materials available. To keep it looking new and for the maximum possible wear, it will need periodic cleaning and maintenance.

Washing: The fabric should be washed often using soap, warm water and a soft bristle brush. Rinse with clear water to remove all traces of soap or use Bestop-recommended Bestop Cleaner and Bestop Protectant. Bestop Cleaner and Bestop Protectant are specially formulated to provide a total cleaning and protection system. Bestop Cleaner will not harm vehicle finish, is biodegradable and environmentally friendly. Bestop Protectant protects against UV-fading, cracking and hardening.

Water: Seeping through at the seams may be stopped by applying 3-M Scotchgard® on the inside of the seams. Rips in the fabric may be repaired with Bondex® iron on patches. Iron the patches to the Inside of the top, carefully following the Bondex® instructions.

Snaps: Keep snaps cleaned and lubricated to help prevent snaps from sticking to the studs. If a snap does become stuck to a stud, use a screwdriver and GENTLY pry apart to prevent permanent damage to the snap or the fabric.

BESTOP TONNEAU COVERS LIMITED LIFETIME WARRANTY

What's covered?

All defects in materials or workmanship on Bestop Tonneau Covers for pick-up truck beds. This warranty does not apply to other Bestop products.

This warranty and any implied warranties including merchantability and fitness for a particular purpose, lasts as long as the original retail purchaser owns the vehicle upon which the tonneau cover is installed. The warranty expires should the product be removed from the original vehicle or if the original vehicle is transferred to another owner. This warranty is not transferable.

What Bestop will do.

During the warranty period as written above, Bestop shall, at its option, either repair or replace any defective product at no charge. Bestop will not pay for labor charges associated with installation or removal of the product. Should a specific product be discontinued, Bestop may, at its option replace the discontinued product with a current product or like product.

The Warranty does not cover:

Damage, defect, or malfunction caused by misuse, abuse, accident, fire, improper installation, modification, improper or inadequate maintenance, or hazards, or acts of God. Incidental or consequential damages are not covered under this warranty. Some states do not allow exclusion or limitation, so this may not apply to you. This warranty gives you specific legal rights, and you may have other rights which vary from state to state.

Warranty Service:

Retain your proof of purchase. Proof of purchase must accompany any warranty claim. A defective item should be returned to the place of purchase. Bestop's Customer Service may be contacted for help determining whether a product is defective. Bestop Customer Service may be reached a 1-800-845-3567, or via e-mail at cs@bestop.com.



For further information or request for warranty work, please contact:
Bestop Inc., Customer Service
Toll-Free: (800)845-3567
E-mail: customerservice@Bestop.com
Website: www.Bestop.com