



Windshield Header Installation Instructions



For: Ford Bronco 1966 - 1977

Part Number: 51206



WARNING

This product is designed to enhance the appearance of the vehicle and to shield the occupants from ordinary weather conditions. Do not rely in any way on the components of this product to contain occupants within the vehicle, or to protect against injury or death in the event of an accident. This product will not protect the occupants from falling objects. Never operate vehicle in excess of manufacturer's specifications.

WEAR SEAT BELTS AT ALL TIMES

Read and follow, precisely, all installation instructions provided when installing this product. Failure to do so may result in a poor fit and could place occupants of the vehicle in a potentially dangerous situation. Failure to properly install or reinstall this product may cause the top or a component part to come off the vehicle, potentially causing an accident and possible injury to the occupants of the vehicle. After installing or reinstalling the top, check to make sure it has been properly installed.

Installation Tips

Before you begin installing this windshield header, read all instructions thoroughly. After completing the installation, keep these instructions for further reference.

Parts List and Hardware Identification



Windshield Header -
Driver's Side, Qty - 1

Windshield Header -
Passenger Side, Qty - 1

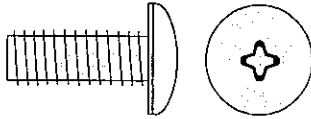

1/4-20 x 3/4" Pan Head Bolt,
Qty - 8, Part Number 257.92



1/4-20 Hex Lock Nut, Qty - 8,
Part Number 198.26

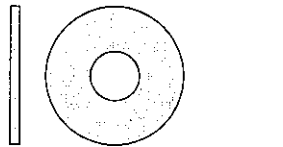

1/4" x 3/4" OD Washer, Qty - 16,
Part Number 257.93

Tools Needed

Adjustable Wrench
Phillips Screw Driver
Safety Glasses

Windshield Adjustment

Step One

Check Windshield Adjustment

Measure from the inside edge of the windshield frame to the inside edge of the tailgate. This measurement should be 83-3/4" - 84" or the top will not fit or function properly. If the measurement is slightly more than 84" the tension from the top may pull it into position. If the measurement is less than 83-3/4", loosen the bolts on both sides of the windshield frame, place shims under the frame and re-tighten the bolts.

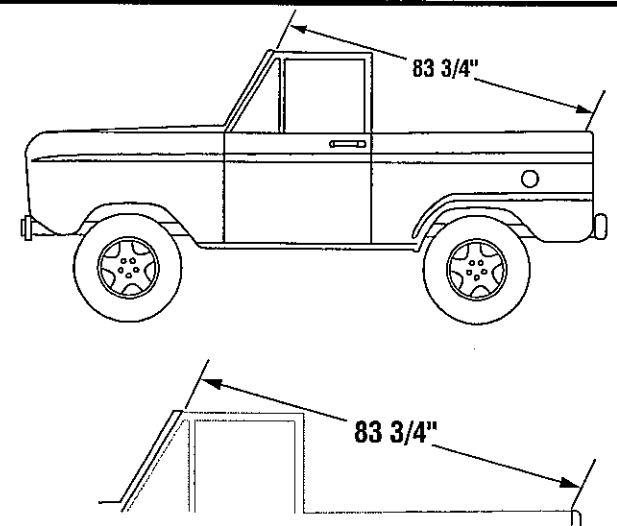

Hardware Installation

Step One

Install Windshield Adapter

Orient the two pieces of the Windshield Adapter on the windshield frame with the curve toward the outside of the vehicle and the lip toward the front. Align the holes in the adapter with the holes in the frame. Install a 1/4-20 x 3/4" Pan Head Bolt, a 1/4-20 Hex Lock Nut and two 1/4 x 3/4 OD Flat Washers in each hole.

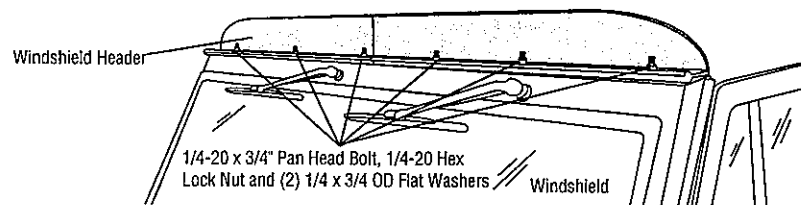

Note: If there is any weatherstripping along the top of the windshield frame it should be removed.

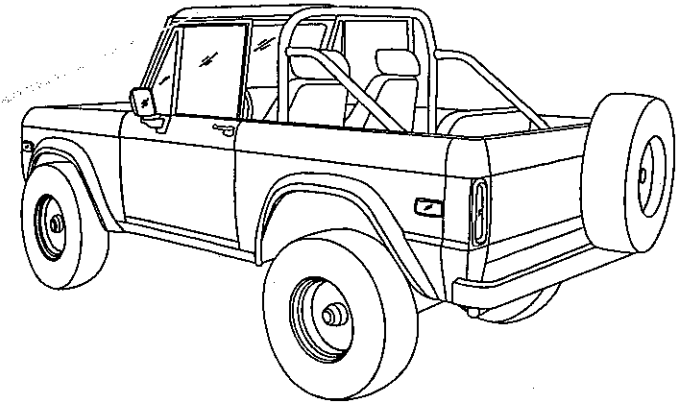

Step Two

If Windshield Wiper Motor Cover interferes with Adapter Installation

If your vehicle has a plastic windshield wiper motor cover that interferes with the installation of the Windshield Adapter you will need to trim the sides of the cover. Remove the cover and use the templates provided to mark the areas to be trimmed. Reinstall the cover.

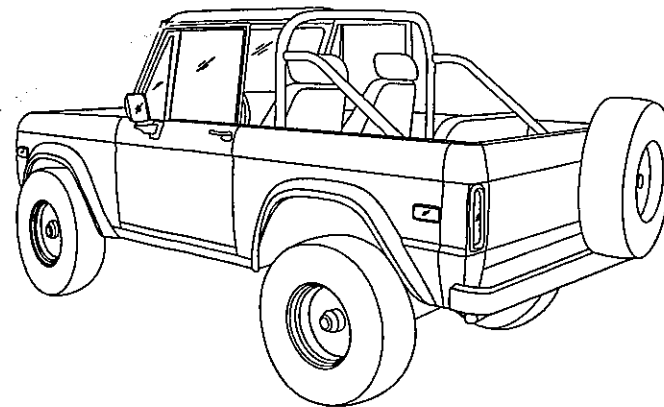
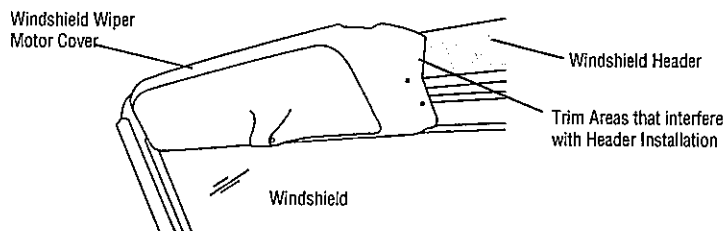

Templates for Windshield Wiper Motor Cover

Cut out the template and position it on the wiper motor cover. Mark the cover along the straight edge of the template. Cut the cover along the line.

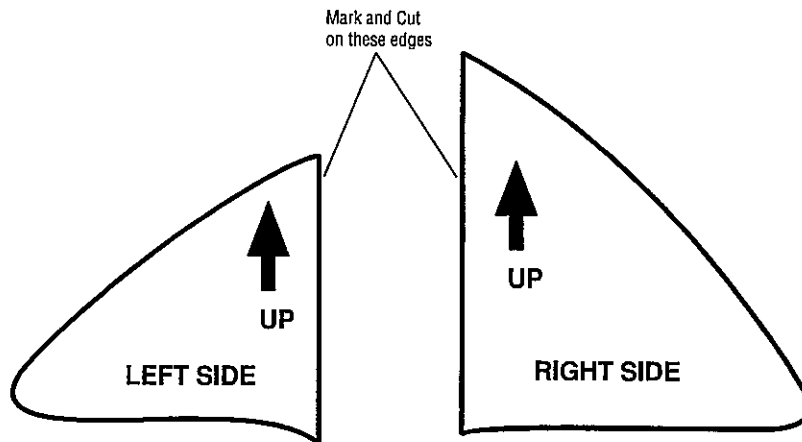

LIMITED WARRANTY

We warrant our product to be free from defects in material and workmanship, for the terms specified below, provided there has been normal use and proper maintenance. This warranty applies to the original purchaser only. All remedies under this warranty are limited to the repair or replacement of any item or items found by the factory to be defective within the time period specified.

If you have a warranty claim, first you must call our factory at the number below for instructions. You must retain proof of purchase and submit a copy with any items returned for warranty work. Upon completion of warranty work, if any, we will return the repaired or replaced item or items to you freight prepaid. Damage to our products caused by accidents, fire, vandalism, negligence, misinstallation, misuse, Acts of God, or by defective parts not manufactured by us, is not covered under this warranty.

THE WARRANTY TIME PERIOD IS AS FOLLOWS: ALL "SOFT GOODS" MANUFACTURED BY OUR COMPANY (USING PRIMARILY VINYL, PLASTICS, AND/OR FOAM): ONE YEAR FROM DATE OF PURCHASE.

ANY IMPLIED WARRANTIES OF MERCHANTABILITY AND/OR FITNESS FOR A PARTICULAR PURPOSE CREATED HEREBY ARE LIMITED IN DURATION TO THE SAME DURATION AND SCOPE AS THE EXPRESS WRITTEN WARRANTY. OUR COMPANY SHALL NOT BE LIABLE FOR ANY INCIDENTAL OR CONSEQUENTIAL DAMAGE.

Some states do not allow limitations on how long an implied warranty lasts, or the exclusion or limitation of incidental or consequential damages, so the above limitations or exclusions may not apply to you.

This warranty gives you specific legal rights, and you may also have other rights which vary from state to state.

For further information or request for warranty work, please contact:

Bestop Inc.
Customer Service
(800)346-3910
(303)465-1755