



Installation Instructions Rear Upper Door



(to be used with Element Door)

Vehicle Application

- Jeep JL Wrangler Unlimited
2018 and Newer
Part Number: 51743

www.Bestop.com - We're here to help! Visit our web site and click on "[Ask a Question](#)". Click here for more [Jeep Accessories by Bestop](#).

INSTALLATION TIME	SKILL LEVEL
 <p>1/2 Hour</p>	<p>1 2 3 4</p> <p>1 - Easy</p>

TOOLS		
 <p>Safety Glasses</p>	 <p>50/50 Solution Alcohol/Water</p>	 <p>Soft Cloth</p>





Installation Tips

Before you begin installing this assembly, read all instructions thoroughly.

For a smooth fit:

For ease in installation, the product should be installed at temperatures above 72° F. Below this temperature, the fabric may contract an inch or more, making it difficult to fit to the vehicle. It is normal for fabric to contract and wrinkle when stored in the shipping carton. Within a few days after the installation, the fabric will relax and the wrinkles will disappear.

 **CAUTION** Safety glasses should be worn at all times while installing this product.

 **WARNING** This product is designed primarily to enhance the appearance of the vehicle and to shield the occupants from ordinary weather conditions. Do not rely in any way on the components of this product to contain occupants within the vehicle, or to protect against injury or death in the event of an accident. This product will not protect the occupants from falling objects. Never operate the vehicle in excess of manufacturer's specifications.

WEAR SEAT BELTS AT ALL TIMES

Read and follow, precisely, all installation instructions provided when installing product. Failure to do so may result in a poor fit and could place occupants of the vehicle in a potentially dangerous situation.

Rear Upper Door – Installation Instructions

Parts List

Upper Door, Rt. Qty - 1
 Upper Door, Lt. Qty - 1
 58" Adhesive Loop Strip, Part Number 546.15 Qty - 1



Zipper Lubricant
 Qty - 1
 Part Number 529.22

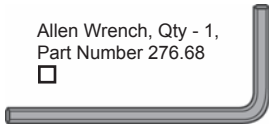

Allen Wrench, Qty - 1,
 Part Number 276.68

WARNING

The doors in this product are designed only for protection against the elements. Do not rely on the doors to contain occupants within the vehicle or to protect against injury during an accident. Door handles are only designed to aid in door closure. Door and handle will not support a person's weight.

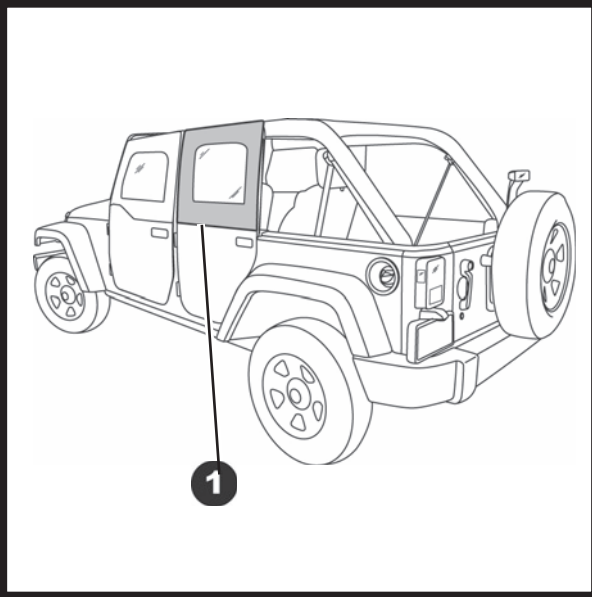

1 Install Upper Door

Install the upper door into the lower door. Starting with the front pin, slip the pins into the sockets in the lower door. Make sure that the pins are well seated in the sockets. Close the door to check that it fits properly against the body. If necessary, use a 1/8" Allen Wrench to loosen the Collars on the front and rear upper door pins. The Collars will slide up or down as needed to provide the best fit of the Upper Door against the windshield.

NOTE Lubricate the upper door pins with a light weight oil to make it easier to install and remove the upper door.

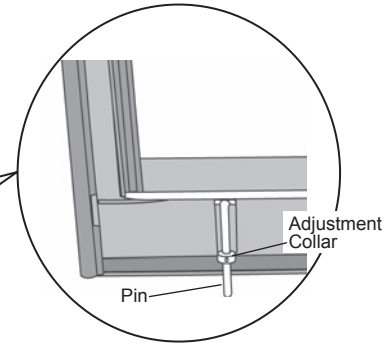
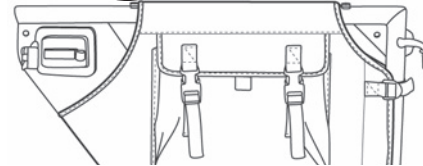
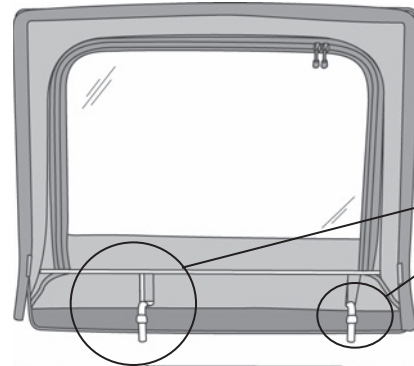

Rear Upper Door – Installation Instructions

2 Install Adhesive Hook Strip

Locate the Adhesive Loop Strip in the parts kit. Cut it into two (2) 29" pieces. Install the Adhesive Loop onto the Hook on the inside bottom of the door fabric.

Press the Upper Door against the Element Door to make sure that the Adhesive Loop Strip will lay flat on the surface of the Element Door. Adjust the Adhesive Loop Strip if necessary.

Clean the area on the Element Door where the Adhesive Loop Strip will be installed using a 50/50 alcohol / water mixture. Carefully peel the paper backing off the Adhesive Loop Strip and press it firmly onto the Element door.

The adhesive requires 72 hours to cure completely. Please leave the Upper Door in position until the adhesive is fully cured.

NOTE The Adhesive Loop Strip secures the upper door to the lower door and can be applied to the JK Element tubular frame or to the JK Element door with Enclosure kit.

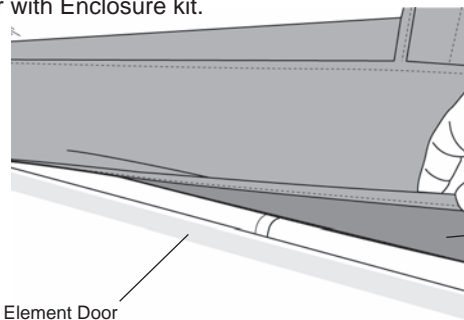
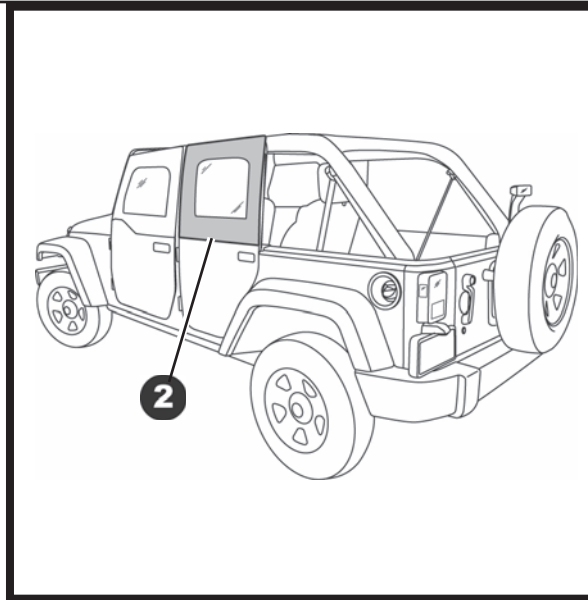

Clean area on Element Door Frame or Enclosure Kit and install Adhesive Loop Strip

Use Hook Strip on Upper Door as a guide to install Adhesive Loop Strip on Element Door

Rear Upper Door – Installation Instructions

Care and Maintenance of your Bestop Product

Your Bestop product is made of the finest materials available. To keep it looking new and for the maximum possible wear, it will need periodic cleaning and maintenance.

Washing: The fabric should be washed often using soap, warm water and a soft bristle brush. Rinse with clear water to remove all traces of soap or use Bestop-recommended Bestop Cleaner and Bestop Protectant. Bestop Cleaner and Bestop Protectant are specially formulated to provide a total cleaning and protection system. Bestop Cleaner will not harm vehicle finish, is biodegradable and environmentally friendly. Bestop Protectant protects against UV-fading, cracking and hardening.

Zippers: Keeping the zipper cleaned and lubricated with a silicone lubricant will help prevent damage and keep the zippers in a smooth working condition. If a zipper opens behind the slider, the slider may have been spread apart. This problem can usually be repaired by using an ordinary pair of pliers to bring the sides back into parallel. Return slider to the end of the zipper in the normal Open position. Squeeze lightly at first and test the zipper. If the zipper continues to remain open squeeze more firmly with the pliers and try the zipper again. Repeat this procedure until the zipper operates correctly.

Water: Seeping through at the seams may be stopped by applying 3-M Scotchgard® on the inside of the seams. Rips in the fabric may be repaired with Bondex® iron on patches. Iron the patches to the Inside of the top, carefully following the Bondex® instructions.

Snaps: Keep snaps cleaned and lubricated with silicone to help prevent snaps from sticking to the studs. If a snap does become stuck to a stud, use a screwdriver and GENTLY pry apart to prevent permanent damage to the snap or the top fabric.

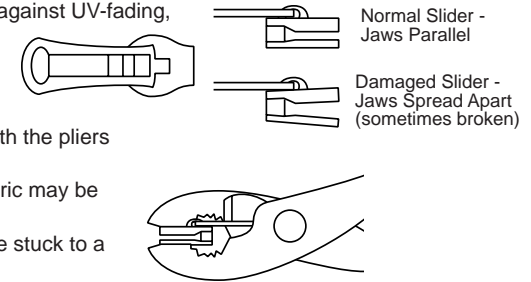

LIMITED WARRANTY

We warrant our product to be free from defects in material and workmanship, for the terms specified below, provided there has been normal use and proper maintenance. This warranty applies to the original purchaser only. All remedies under this warranty are limited to the repair or replacement of any item or items found by the factory to be defective within the time period specified. If you have a warranty claim, first you must call our factory at the number below for instructions. You must retain proof of purchase and submit a copy with any items returned for warranty work. Upon completion of warranty work, if any, we will return the repaired or replaced item or items to you freight prepaid. Damage to our products caused by accidents, fire, vandalism, negligence, misinstallation, misuse, Acts of God, or by defective parts not manufactured by us, is not covered under this warranty.

THE WARRANTY TIME PERIOD IS AS FOLLOWS FOR REPLACE-A-TOP™, SAILCLOTH REPLACE-A-TOP™, SUPERTOP®, SUPERTOP® REPLACEMENT SKINS, SUNRIDER®, AND TIGERTOP®: TWO YEARS FROM DATE OF PURCHASE.

THE WARRANTY TIME PERIOD IS AS FOLLOWS FOR ALL OTHER "SOFT GOODS" MANUFACTURED BY OUR COMPANY (USING PRIMARILY VINYL, PLASTICS, AND/OR FOAM): ONE YEAR FROM DATE OF PURCHASE.

THE WARRANTY TIME PERIOD IS AS FOLLOWS FOR ALL OTHER "HARD GOODS" MANUFACTURED BY OUR COMPANY (USING PRIMARILY METALS, PLASTICS, AND/OR FIBERGLASS): ONE YEAR FROM DATE OF PURCHASE.

ANY IMPLIED WARRANTIES OF MERCHANTABILITY AND/OR FITNESS FOR A PARTICULAR PURPOSE CREATED HEREBY ARE LIMITED IN DURATION TO THE SAME DURATION AND SCOPE AS THE EXPRESS WRITTEN WARRANTY. OUR COMPANY SHALL NOT BE LIABLE FOR ANY INCIDENTAL OR CONSEQUENTIAL DAMAGE.

Some states do not allow limitations on how long an implied warranty lasts, or the exclusion or limitation of incidental or consequential damages, so the above limitations or exclusions may not apply to you. This warranty gives you specific legal rights, and you may also have other rights which vary from state to state.



For further information or request for warranty work, please contact:
Bestop Inc., Customer Service
Toll-Free: (800)845-3567
E-mail: csbestop@Bestop.com
Website: www.Bestop.com